

Document No.	853-1010
ECN No.	96898
Date of Issue	May 11, 1990
Status	Product Specification
ACL Products	

AC11239: Product Specification

ACT11239: Preliminary Specification

Dual 2-to-4 line decoder/demultiplexer, active-High

FEATURES

- Demultiplexing capability
- Two independent 1-of-4 decoders
- Non-inverting outputs
- Output capability: ± 24 mA
- CMOS (AC) and TTL (ACT) voltage level inputs
- 50 Ω incident wave switching
- Center-pin V_{CC} and ground configuration to minimize high-speed switching noise
- I_{CC} category: MSI

DESCRIPTION

The 74AC/ACT11239 high-performance CMOS devices combine very high speed and high output drive comparable to the most advanced TTL families.

The 74AC/ACT11239 has two independent decoders, each accepting two binary weighted inputs (nA_0, nA_1) and providing four mutually exclusive active-High outputs ($nY_0 - nY_3$). Each decoder has an active-Low Enable ($n\bar{E}$). When \bar{E} is High, every output is forced Low. The Enable can be used as the Data input for a 1-of-4 demultiplexer application.

QUICK REFERENCE DATA

SYMBOL	PARAMETER	CONDITIONS $T_{amb} = 25^\circ\text{C}; \text{GND} = 0\text{V};$ $V_{CC} = 5.0\text{V}$	TYPICAL		UNIT
			AC	ACT	
t_{PLH}/t_{PHL}	Propagation delay nA_n to nY_n	$C_L = 50\text{pF}$	3.9	5.2	ns
C_{PD}	Power dissipation capacitance per decoder ¹	$f = 1\text{MHz}; C_L = 50\text{pF}$	48	50	pF
C_{IN}	Input capacitance	$V_I = 0\text{V}$ or V_{CC}	3.5	3.5	pF
I_{LATCH}	Latch-up current	Per Jeduc JC40.2 Standard 17	500	500	mA

Note:

1. C_{PD} is used to determine the dynamic power dissipation (P_D in μW):

$$P_D = C_{PD} \times V_{CC}^2 \times f_I + \sum (C_L \times V_{CC}^2 \times f_O)$$

f_I = input frequency in MHz, C_L = output load capacitance in pF,

f_O = output frequency in MHz, V_{CC} = supply voltage in V,

$\sum (C_L \times V_{CC}^2 \times f_O)$ = sum of outputs

ORDERING INFORMATION

PACKAGES	TEMPERATURE RANGE	ORDER CODE
16-pin plastic DIP (300mil-wide)	-40°C to +85°C	74AC11239N 74ACT11239N
16-pin plastic SO (150mil-wide)	-40°C to +85°C	74AC11239D 74ACT11239D

PIN CONFIGURATION

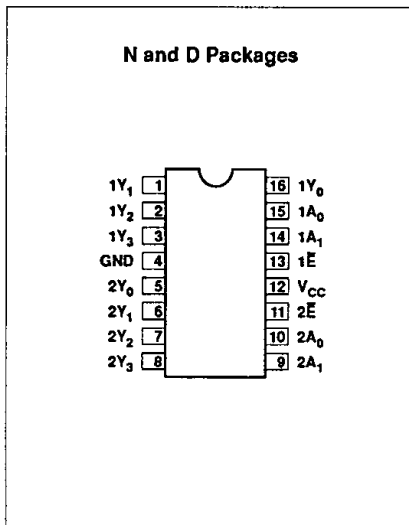

LOGIC SYMBOL

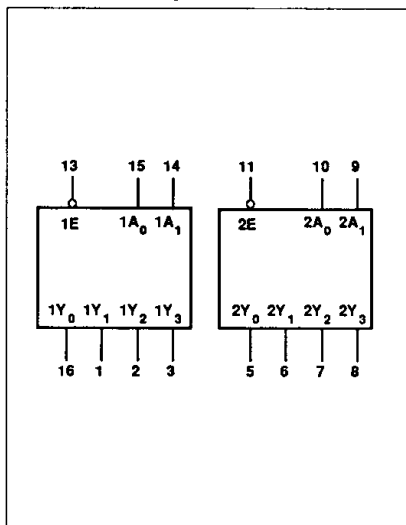

LOGIC SYMBOL (IEEE/IEC)

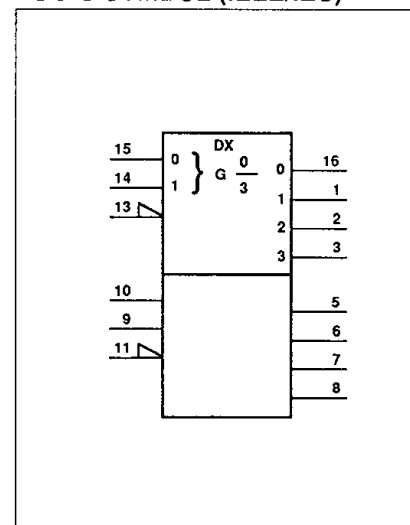

Dual 2-to-4 line decoder/demultiplexer, active-High

74AC/ACT11239

PIN DESCRIPTION

PIN NUMBER	SYMBOL	NAME AND FUNCTION
15, 14	1A ₀ , 1A ₁	Address inputs, decoder 1
13	1 \bar{E}	Enable input (active Low), decoder 1
16, 1, 2, 3	1Y ₀ to 1Y ₃	Outputs, decoder 1
10, 9	2A ₀ , 2A ₁	Address inputs, decoder 2
11	2 \bar{E}	Enable input (active Low), decoder 2
5, 6, 7, 8	2Y ₀ to 2Y ₃	Outputs, decoder 2
4	GND	Ground (0V)
12	V _{CC}	Positive supply voltage

FUNCTION TABLE

INPUTS			OUTPUTS			
\bar{E}	A ₀	A ₁	Y ₀	Y ₁	Y ₂	Y ₃
H	X	X	L	L	L	L
L	L	L	H	L	L	L
L	H	L	L	H	L	L
L	L	H	L	L	H	L
L	H	H	L	L	L	H

LOGIC DIAGRAM

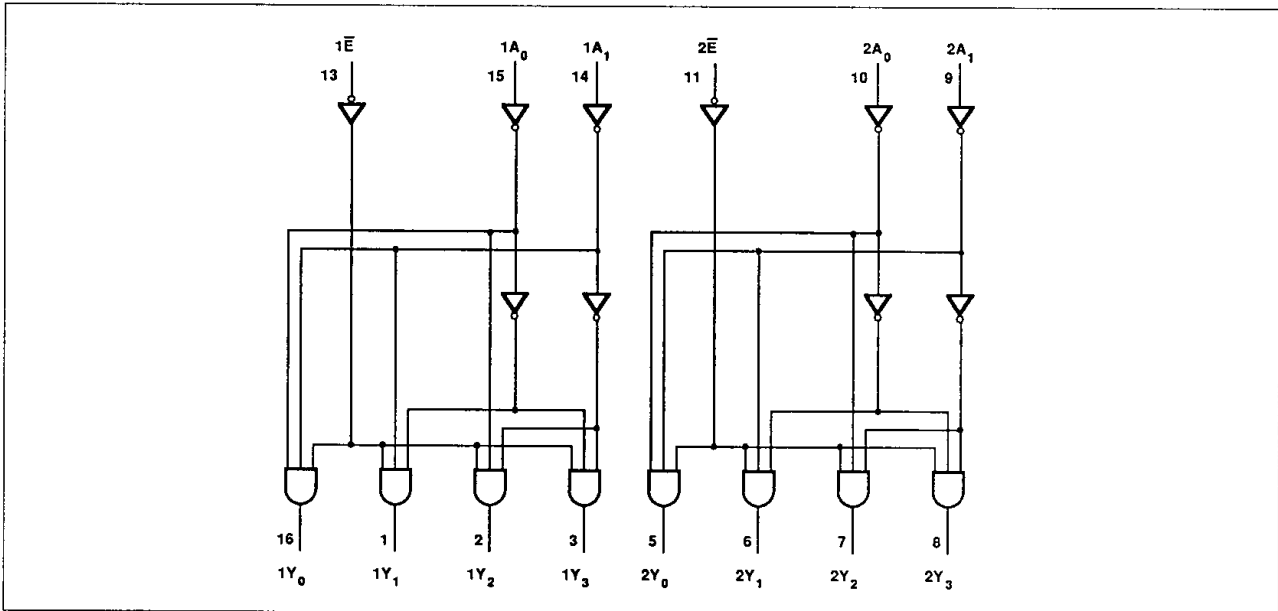

Dual 2-to-4 line decoder/demultiplexer, active-High

74AC/ACT11239

RECOMMENDED OPERATING CONDITIONS

SYMBOL	PARAMETER	74AC11239			74ACT11239			UNIT
		Min	Nom	Max	Min	Nom	Max	
V_{CC}	DC supply voltage	3.0 ¹	5.0	5.5	4.5	5.0	5.5	V
V_I	Input voltage	0		V_{CC}	0		V_{CC}	V
V_O	Output voltage	0		V_{CC}	0		V_{CC}	V
$\Delta V/\Delta t$	Input transition rise or fall rate	0		10	0		10	ns/V
T_{amb}	Operating free-air temperature range	-40		+85	-40		+85	°C

NOTE:

- No electrical or switching characteristics are specified at $V_{CC} < 3V$. Operation between 2V and 3V is not recommended, but within that range, a device output will maintain a previously established logic state.

ABSOLUTE MAXIMUM RATINGS¹

SYMBOL	PARAMETER	TEST CONDITIONS	RATING	UNIT
V_{CC}	DC supply voltage		-0.5 TO +7.0	V
I_{IK} or V_I	DC input diode current ²	$V_I < 0$	-20	mA
		$V_I > V_{CC}$	20	
	DC input voltage		-0.5 to $V_{CC} + 0.5$	V
I_{OK} or V_O	DC output diode current ²	$V_O < 0$	-50	mA
		$V_O > V_{CC}$	50	
	DC output voltage		-0.5 to $V_{CC} + 0.5$	V
I_O	DC output source or sink current per output pin	$V_O = 0$ to V_{CC}	±50	mA
I_{CC} or I_{GND}	DC V_{CC} current		±200	mA
	DC ground current		±200	
T_{STG}	Storage temperature		-65 to 150	°C
P_{TOT}	Power dissipation per package	Above 70°C; derate linearly by 8mW/K	500	mW
	Power dissipation per package Plastic surface mount (SO)	Above 70°C; derate linearly by 8mW/K	400	mW

NOTES:

- Stresses beyond those listed may cause permanent damage to the device. These are stress ratings only and functional operation of the device at these or any other conditions beyond those indicated under "recommended operating conditions" is not implied. Exposure to absolute-maximum-rated conditions for extended periods may affect device reliability.
- The input and output voltage ratings may be exceeded if the input and output current ratings are observed.

Dual 2-to-4 line decoder/demultiplexer, active-High

74AC/ACT11239

DC ELECTRICAL CHARACTERISTICS

SYMBOL	PARAMETER	TEST CONDITIONS	V _{CC}	74AC11239				74ACT11239				UNIT	
				T _{amb} = +25°C		T _{amb} = -40°C to +85°C		T _{amb} = +25°C		T _{amb} = -40°C to +85°C			
				Min	Max	Min	Max	Min	Max	Min	Max		
V _{IH}	High-level input voltage		3.0	2.10		2.10						V	
			4.5	3.15		3.15		2.0		2.0			
			5.5	3.85		3.85		2.0		2.0			
V _{IL}	Low-level input voltage		3.0		0.90		0.90					V	
			4.5		1.35		1.35		0.8		0.8		
			5.5		1.65		1.65		0.8		0.8		
V _{OH}	High-level output voltage	V _I = V _{IL} or V _{IH}	I _{OH} = -50μA	3.0	2.9		2.9					V	
				4.5	4.4		4.4		4.4		4.4		
				5.5	5.4		5.4		5.4		5.4		
			I _{OH} = -4mA	3.0	2.58		2.48						
				4.5	3.94		3.8		3.94		3.8		
				5.5	4.94		4.8		4.94		4.8		
I _{OH} = -75mA ¹	5.5			3.85				3.85					
V _{OL}	Low-level output voltage	V _I = V _{IL} or V _{IH}	I _{OL} = 50μA	3.0		0.1		0.1				V	
				4.5		0.1		0.1		0.1			0.1
				5.5		0.1		0.1		0.1			0.1
			I _{OL} = 12mA	3.0		0.36		0.44					
				4.5		0.36		0.44		0.36			0.44
				5.5		0.36		0.44		0.36			0.44
I _{OL} = 75mA ¹	5.5				1.65				1.65				
I _I	Input leakage current	V _I = V _{CC} or GND	5.5		±0.1		±1.0		±0.1		±1.0	μA	
I _{CC}	Quiescent supply current	V _I = V _{CC} or GND, I ₀ = 0mA	5.5		8.0		80		8.0		80	μA	
ΔI _{CC}	Supply current, TTL inputs High ²	One input at 3.4V, other inputs at V _{CC} or GND	5.5						0.9		1.0	mA	

NOTES:

1. Not more than one output should be tested at a time, and the duration of the test should not exceed 10ms.
2. This is the increase in supply current for each input that is at one of the specified TTL voltage levels rather than 0V or V_{CC}.

Dual 2-to-4 line decoder/demultiplexer, active-High

74AC/ACT11239

AC ELECTRICAL CHARACTERISTICS AT 3.3V ±0.3V

SYMBOL	PARAMETER	WAVEFORM	74AC11239					UNIT
			T _{amb} = +25°C			T _{amb} = -40°C to +85°C		
			Min	Typ	Max	Min	Max	
t _{PLH} t _{PHL}	Propagation delay nA _n to nY _n	1 and 2	1.5 1.5	6.2 5.6	8.5 8.0	1.5 1.5	9.5 9.0	ns
t _{PLH} t _{PHL}	Propagation delay n \bar{E} to nY _n	2	1.5 1.5	5.4 5.7	7.1 7.3	1.5 1.5	7.9 8.1	ns

AC ELECTRICAL CHARACTERISTICS AT 5.0V ±0.5V

SYMBOL	PARAMETER	WAVEFORM	74AC11239					UNIT
			T _{amb} = +25°C			T _{amb} = -40°C to +85°C		
			Min	Typ	Max	Min	Max	
t _{PLH} t _{PHL}	Propagation delay nA _n to nY _n	1 and 2	1.5 1.5	4.0 3.7	6.1 6.1	1.5 1.5	6.7 6.8	ns
t _{PLH} t _{PHL}	Propagation delay n \bar{E} to nY _n	2	1.5 1.5	3.5 3.9	5.3 5.6	1.5 1.5	5.8 6.2	ns

AC ELECTRICAL CHARACTERISTICS AT 5.0V ±0.5V

SYMBOL	PARAMETER	WAVEFORM	74ACT11239					UNIT
			T _{amb} = +25°C			T _{amb} = -40°C to +85°C		
			Min	Typ	Max	Min	Max	
t _{PLH} t _{PHL}	Propagation delay nA _n to nY _n	1 and 2	1.7 1.5	5.0 5.4	6.7 7.2	1.7 1.5	7.2 8.0	ns
t _{PLH} t _{PHL}	Propagation delay n \bar{E} to nY _n	2	1.5 2.6	3.8 5.3	5.8 7.1	1.5 2.6	6.2 7.8	ns

AC WAVEFORMS

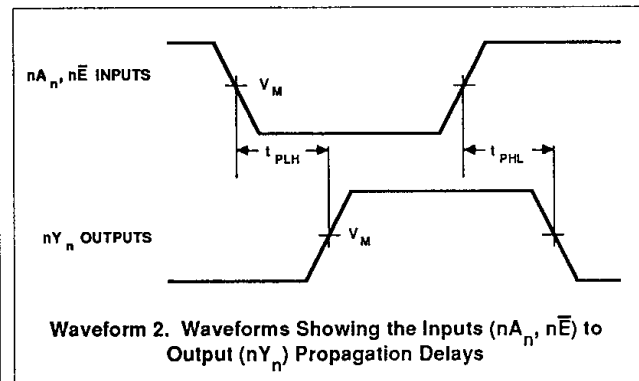
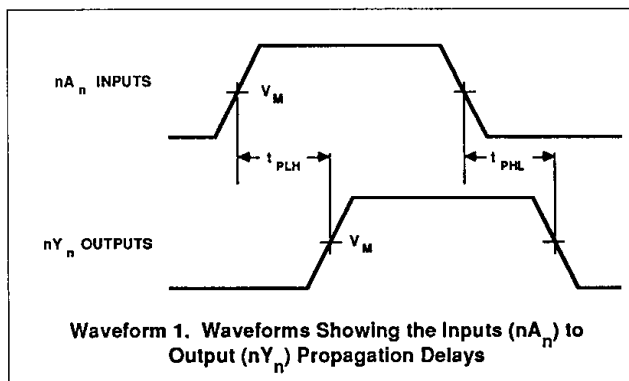

Dual 2-to-4 line decoder/demultiplexer, active-High

74AC/ACT11239

WAVEFORM CONDITIONS

	INPUTS	OUTPUTS
AC	$V_{IN} = \text{GND to } V_{CC}$ $V_M = 50\% V_{CC}$	$V_{OUT} = V_{OL} \text{ to } V_{OH}$
ACT	$V_{IN} = \text{GND to } 3.0V$, $V_M = 1.5V$	$V_M = 50\% V_{CC}$

TEST CIRCUIT

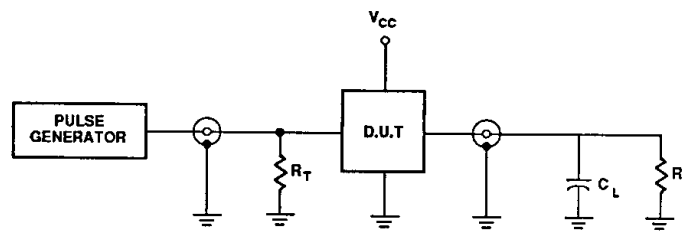

Test Circuit

DEFINITIONS

C_L = Load capacitance, 50pF; includes jig and probe capacitance

R_L = Load resistor, 500Ω

R_T = Termination resistance should be equal to Z_{OUT} of pulse generators

Input pulses: PRR ≤ 10MHz

$t_r = t_f = 3ns$